

Compressor Technical Data

Model **EGM50AZ** Code **547080309616**

LBP

General Data

Refrigerant:	R134a
Application:	LBP
Evaporating Temperature Range:	-30°C to -10°C
Voltage/Frequency:	220-240V 50Hz 1~
Compressor Cooling:	Static
Expansion Device:	Capillary Tube
Packaging Quantity:	Multi - 96:120 pcs
Approvals:	CE-GOST



Mechanical Data

Oil Charge:	270 cm ³
Oil Type Configuration:	ester
Oil Type Viscosity:	19 cSt
Weight:	9.00 kg

Electrical Data

Motor Type:	RSIR
Voltage working range at 50 Hz:	187-264V
Maximum Motor Temperature:	130°C
Locked Rotor Current:	9.46 / 5.26 A
Start Winding Resistance:	25.29 Ω at 25°C
Run Winding Resistance:	15.90 Ω at 25°C
Phase :	1 ph

External Characteristics

Internal Diameter	(mm)
Suction Connector	6.5
Discharge Connector	4.9
Process Connector	6.5
Material	Copper

Electrical Components

Component Type	
Starting Device:	PTC 14 Ω
Motor Protection:	T0462/xx

MCMC compressors reserves the right to change the data without prior notice

10th of Ramadan City - (Cairo) Egypt
 Industrial Zone A-2
 P.o Box : 1001 (10th of Ramadan)
 Tel. : 0554 - 413322 (10 lines)
 Fax. : 0554 - 413161 - 413029
 Web site : <http://www.zmcegypt.com>

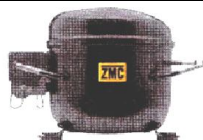

Circuit Diagram for Mod.90 Terminal Board

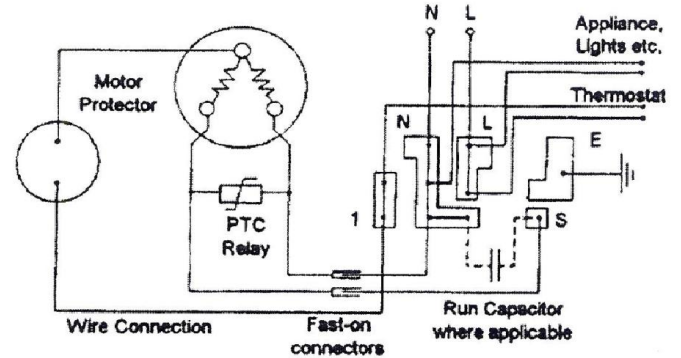

Circuit Diagram for U.H. Terminal Board

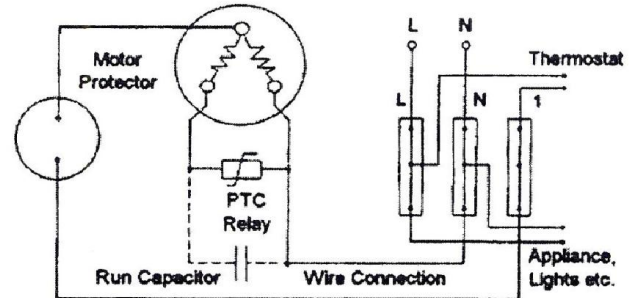

Recommended Transport
Positions when fitted into
appliances

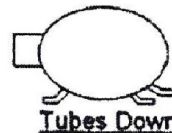
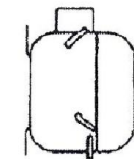
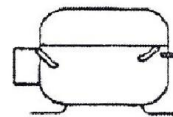

العاشر من رمضان
 المنطقة الصناعية أ - ٢
 ص.ب : ١٠٠١ العاشر من رمضان
 تليفون : ٤١٣٣٢٢ - ٠٥٥٤ (١٠ خطوط)
 فاكس : ٤١٣١٦١ - ٤١٣٠٢٩ (٠٥٥٤)

PERFORMANCE CURVE DATA :

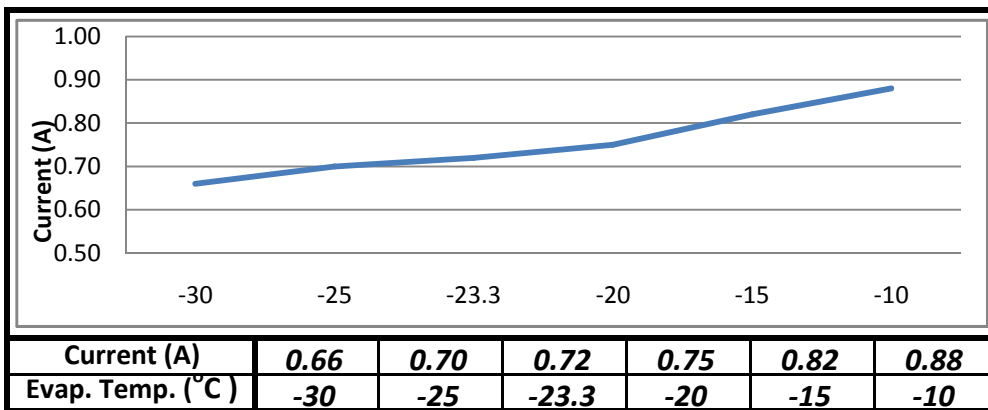
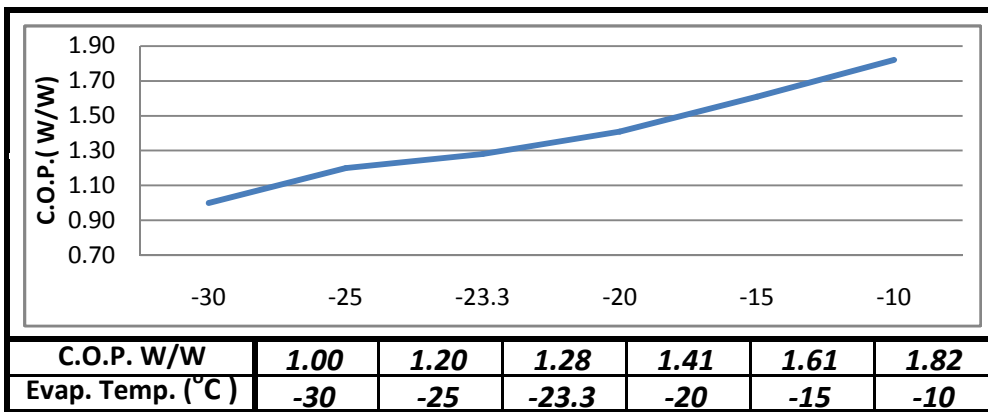
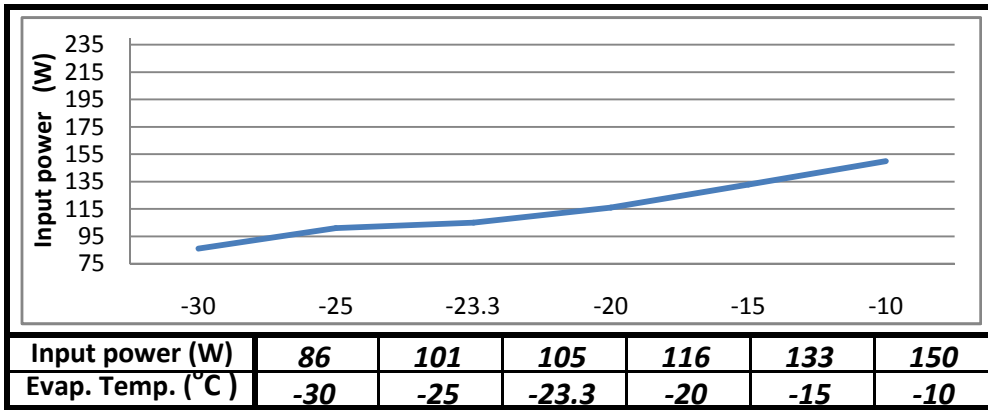
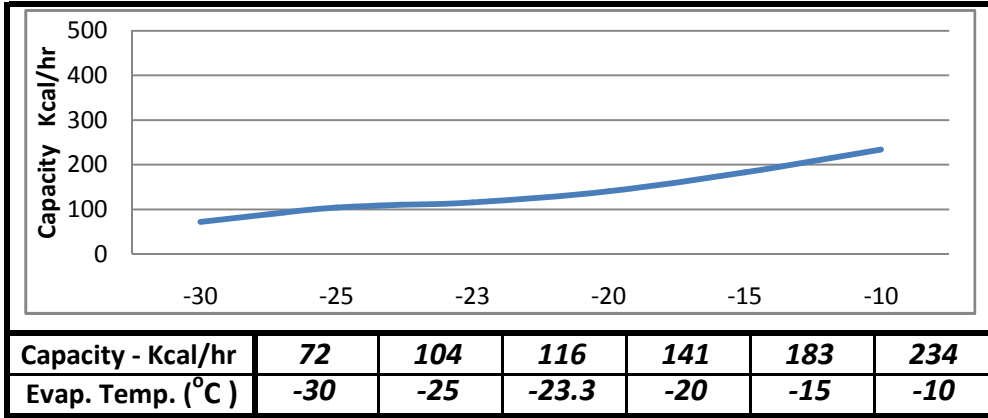

Test Condition: Ashrae, Static, Return Gas 32°C Subcooling OK, Evaporating: 23.3°C, Condensing: 55°C , Ambient: 32°C

10th of Ramadan City - (Cairo) Egypt
 Industrial Zone A-2
 P.o Box : 1001 (10th of Ramadan)
 Tel. : 0554 - 413322 (10 lines)
 Fax. : 0554 - 413161 - 413029
 Web site : <http://www.zmcegypt.com>

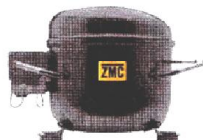

العاشر من رمضان
 المنطقة الصناعية أ - ٢
 ص.ب : ١٠٠١ العاشر من رمضان
 تليفون : ٤١٣٣٢٢ - ٠٥٥٤ (١٠ خطوط)
 فاكس : ٤١٣١٦١ - ٤١٣٠٢٩ (٠٥٥٤)

GM, GN and GL models		HL and HP models	
Standard dimensions for mounting hole centres: 170x70 mm			
<i>Special feet</i>			
Models	Distance between holes	Holes diameter	
GM/GN/HL/HP/GP	165 x 101.6	4 x 19	
	170 x 70	6 x 165	
Tube internal diameter "GM", "GN", "GL", "HL"		"HP" and "GP"	
Material	Suction	Service	Discharge
Copper steel / copper	6.1	6.1	4.9
Copper	6.1	6.1	5.1
Copper	6.5	6.5	4.9
Copper	8.1	8.1	6.5

Mounting accessories

Standard	Standard

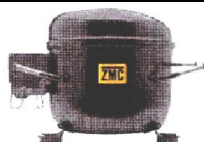

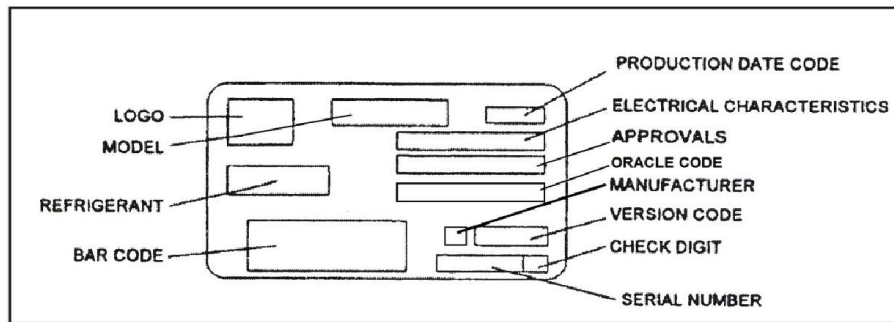
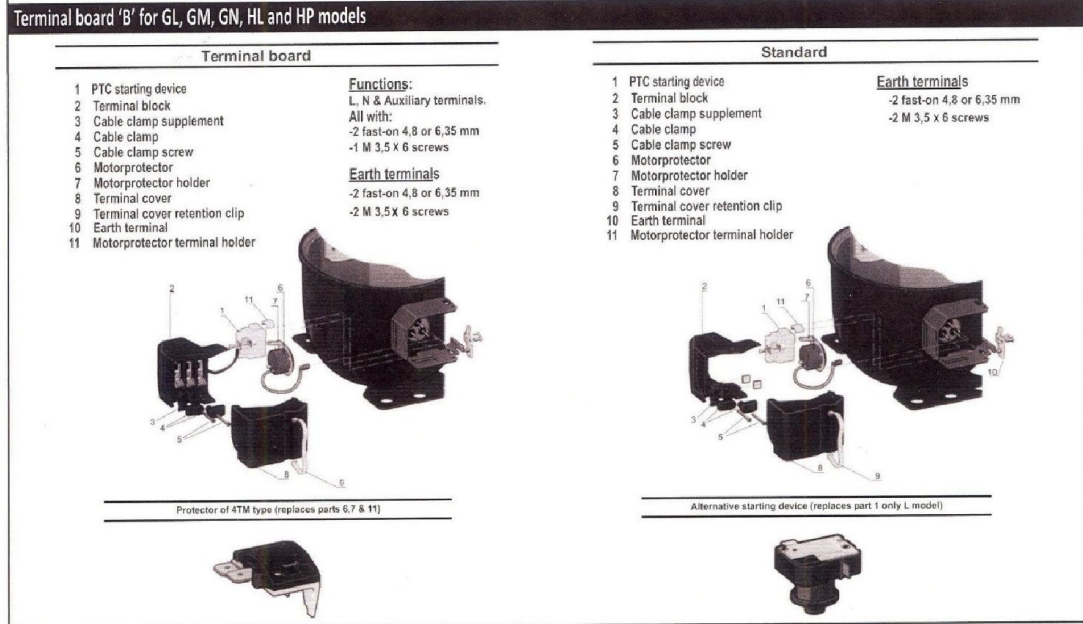
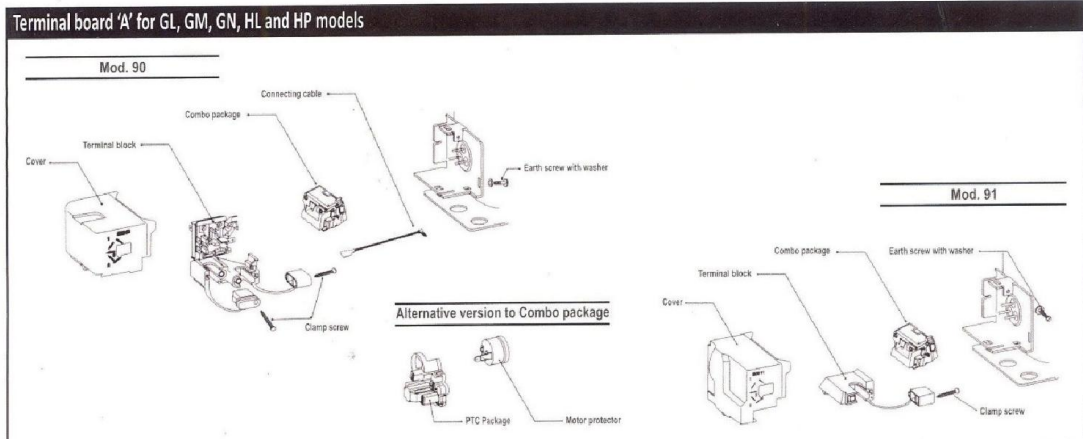

10th of Ramadan City - (Cairo) Egypt
Industrial Zone A-2
P.o Box : 1001 (10th of Ramadan)
Tel. : 0554 - 413322 (10 lines)
Fax. : 0554 - 413161 - 413029
Web site : <http://www.zmcegypt.com>



العاشر من رمضان
المنطقة الصناعية أ - ٢
ص.ب : ١٠٠١ العاشر من رمضان
تليفون : ٤١٣٣٢٢ - ٠٥٥٤ (١٠ خطوط)
فاكس : ٤١٣١٦١ - ٤١٣٠٢٩ (٠٥٥٤)