

## Compressor Technical Data

Model **EGM75AF** Code **507500313816**

**LBP**

### General Data

Refrigerant: R134a  
 Application: LBP  
 Evaporating Temperature Range: -30°C to -10°C  
 Voltage/Frequency: 220-240V 50Hz 1~  
 Compressor Cooling: Static  
 Expansion Device: Capillary Tube  
 Packaging Quantity: Multi - 96:120 pcs  
 Approvals: CE-VDE-GOST



### Mechanical Data

Oil Charge: 350 cm<sup>3</sup>  
 Oil Type Configuration: ester  
 Oil Type Viscosity: 19 cSt  
 Weight: 9.20 kg

### Electrical Data

Motor Type: RSIR / RSCR\*  
 Voltage working range at 50 Hz: 187-264V  
 Maximum Motor Temperature: 130°C  
 Locked Rotor Current: 13.45 / 7.39 A  
 Start Winding Resistance: 14.20 Ω at 25°C  
 Run Winding Resistance: 12.10 Ω at 25°C  
 Phase : 1 ph

### External Characteristics

Internal Diameter (mm)  
 Suction Connector 6.5  
 Discharge Connector 4.9  
 Process Connector 6.5  
 Material Copper

### Electrical Components

Component Type  
 Starting Device: PTC 14Ω  
 Motor Protection: T0502/xx

Circuit Diagram for Mod.90 Terminal Board

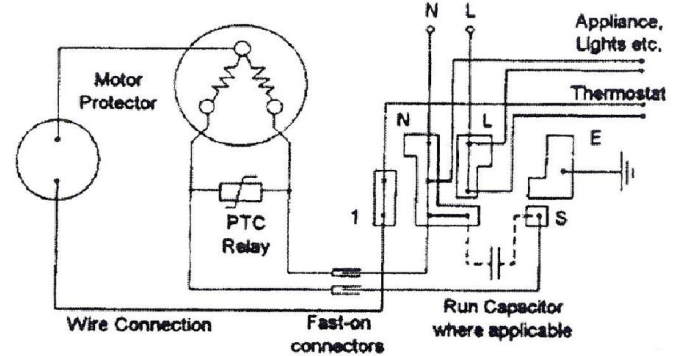

Circuit Diagram for U.H. Terminal Board

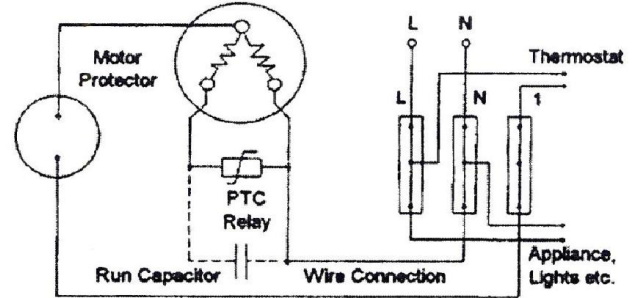

Recommended Transport  
Positions when fitted into  
appliances

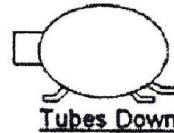
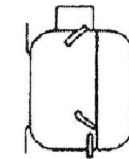
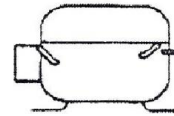

MCMC compressors reserves the right to change the data without prior notice

10th of Ramadan City - (Cairo) Egypt  
 Industrial Zone A-2  
 P.o Box : 1001 ( 10th of Ramadan )  
 Tel. : 0554 - 413322 ( 10 lines )  
 Fax. : 0554 - 413161 - 413029  
 Web site : <http://www.zmcegypt.com>



العاشر من رمضان  
 المنطقة الصناعية أ - ٢  
 ص.ب : ١٠٠١ العاشر من رمضان  
 تليفون : ٤١٣٣٢٢ - ٠٥٥٤ ( ١٠ خطوط )  
 فاكس : ٤١٣١٦١ - ٤١٣٠٢٩ ( ٠٥٥٤ )

**PERFORMANCE CURVE DATA :**

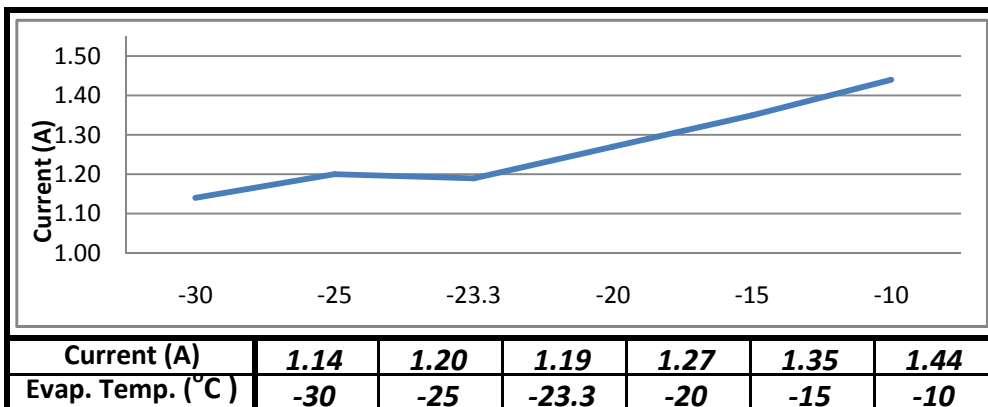
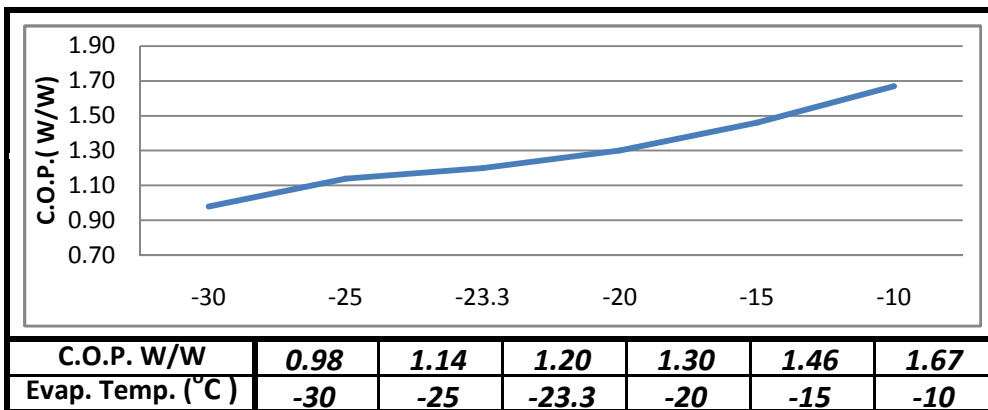
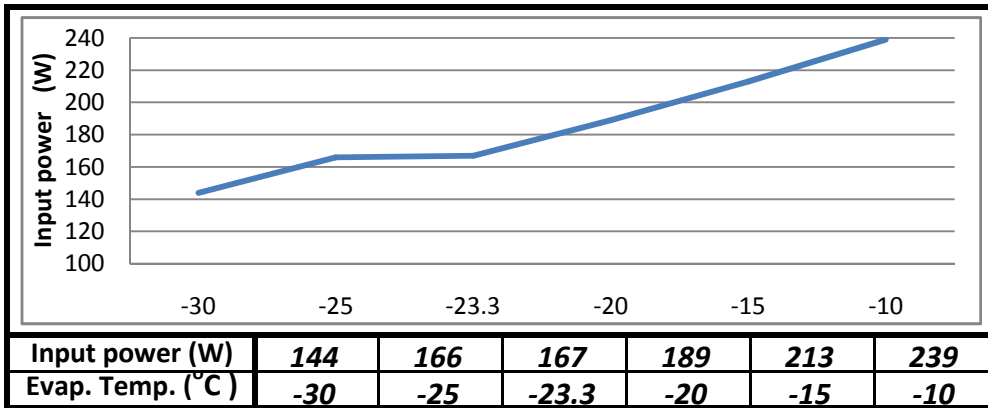
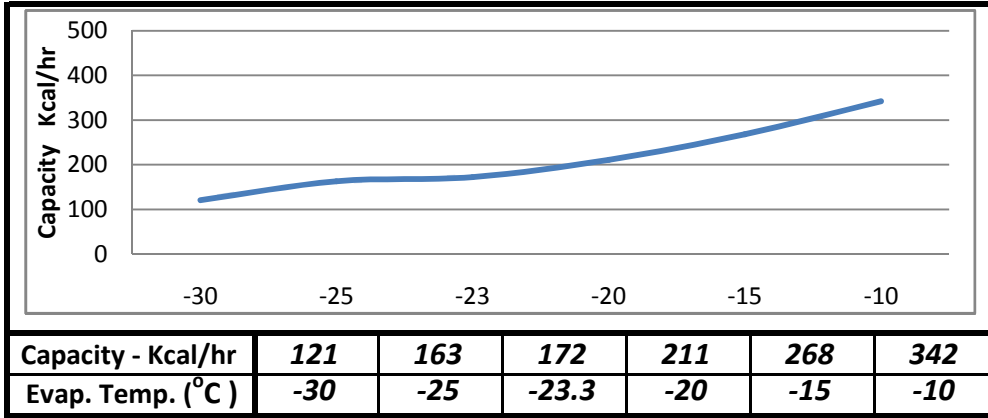

Test Condition: Ashrae, Static, Return Gas 32°C Subcooling OK, Evaporating: 23.3°C, Condensing: 55°C, Ambient: 32°C

10th of Ramadan City - (Cairo) Egypt  
 Industrial Zone A-2  
 P.o Box : 1001 ( 10th of Ramadan )  
 Tel. : 0554 - 413322 ( 10 lines )  
 Fax. : 0554 - 413161 - 413029  
 Web site : <http://www.zmcegypt.com>

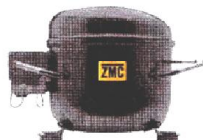

العاشر من رمضان  
 المنطقة الصناعية أ - ٢  
 ص.ب : ١٠٠١ العاشر من رمضان  
 تليفون : ٤١٣٣٢٢ - ٠٥٥٤ ( ١٠ خطوط )  
 فاكس : ٤١٣١٦١ - ٤١٣٠٢٩ ( ٠٥٥٤ )

GM, GN and GL models		HL and HP models	
Standard dimensions for mounting hole centres: 170x70 mm			
<b>Special feet</b>			
Models	Distance between holes	Holes diameter	
GM/GN/HL/HP/GP	165 x 101.6	4 x 19	
	170 x 70	6 x 165	
Tube internal diameter "GM", "GN", "GL", "HL"		"HP" and "GP"	
Material	Suction	Service	Discharge
Copper steel / copper	6.1	6.1	4.9
Copper	6.1	6.1	5.1
Copper	6.5	6.5	4.9
Copper	8.1	8.1	6.5

**Mounting accessories**

Standard	Standard



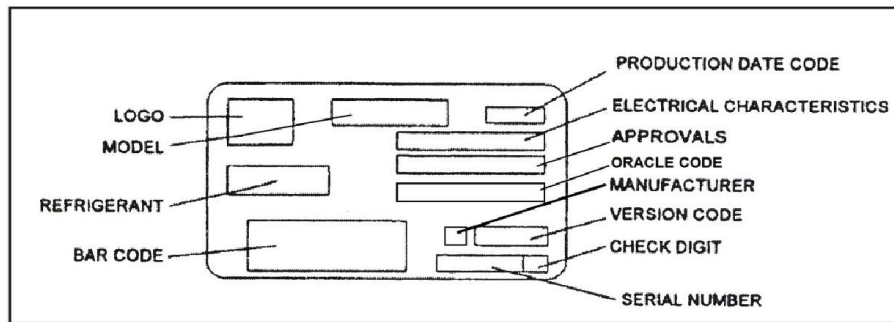
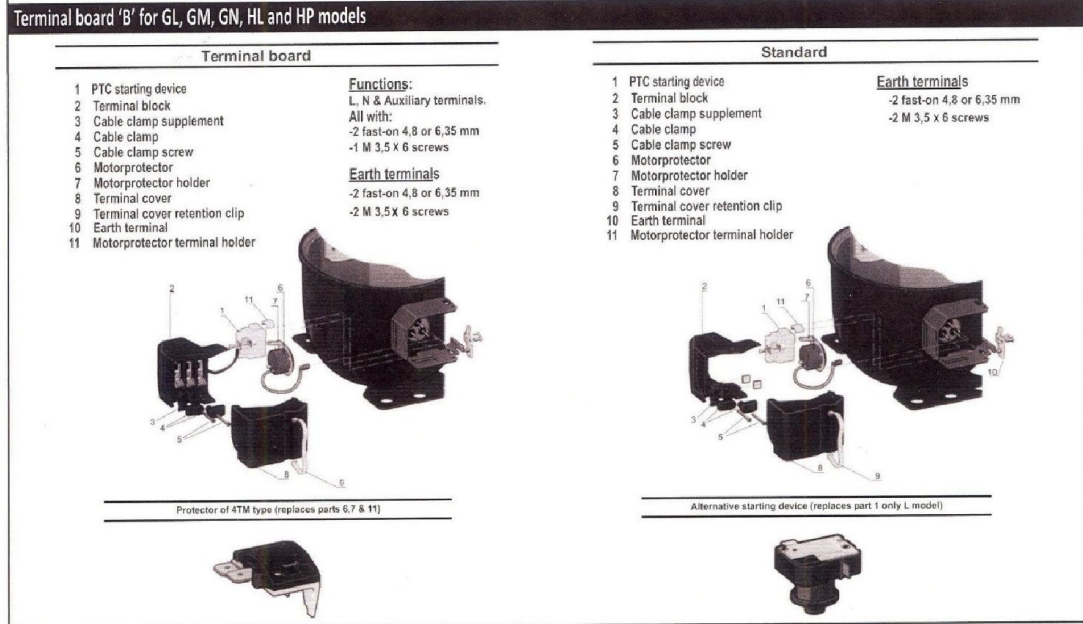
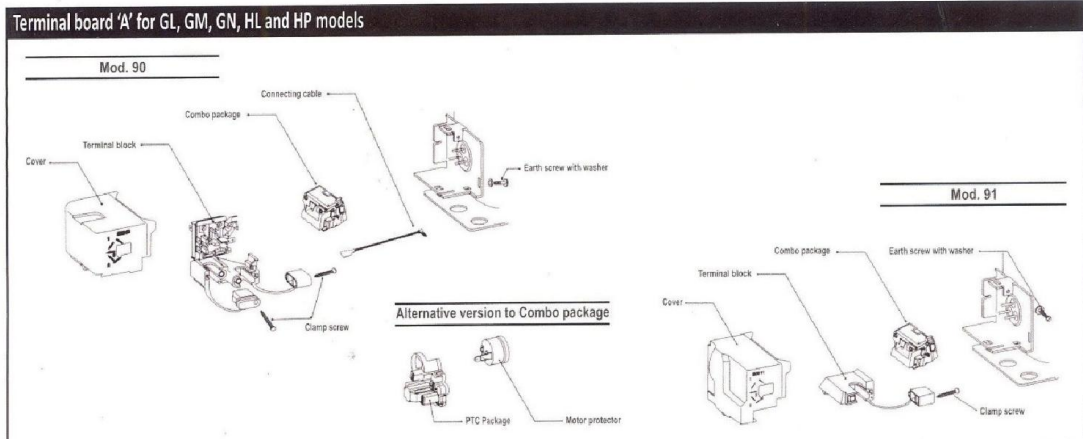

10th of Ramadan City - (Cairo) Egypt  
Industrial Zone A-2  
P.o Box : 1001 ( 10th of Ramadan )  
Tel. : 0554 - 413322 ( 10 lines )  
Fax. : 0554 - 413161 - 413029  
Web site : <http://www.zmcegypt.com>



العاشر من رمضان  
المنطقة الصناعية أ - ٢  
ص.ب : ١٠٠١ العاشر من رمضان  
تليفون : ٤١٣٣٢٢ - ٠٥٥٤ ( ١٠ خطوط )  
فاكس : ٤١٣١٦١ - ٤١٣٠٢٩ ( ٠٥٥٤ )