

Compressor Technical Data

Model **GL70AN** Code **418070341116**

LBP

General Data

Refrigerant: R134a
 Application: LBP
 Evaporating Temperature Range: -30°C to -10°C
 Voltage/Frequency: 200-220V/220-230 50/60Hz 1~
 Compressor Cooling: Static
 Expansion Device: Capillary Tube
 Packaging Quantity: Multi - 96:120 pcs
 Approvals: CE-VDE



Mechanical Data

Oil Charge: 445 cm3
 Oil Type Configuration: ester
 Oil Type Viscosity: 19 cSt
 Weight: 10.40kg

Electrical Data

Motor Type: RSIR
 Voltage working range at 50/60 Hz: 170-242V /187-253V
 Maximum Motor Temperature: 130°C
 Locked Rotor Current 50 Hz: 16.5 / 11.2 A
 Locked Rotor Current 60 Hz: 15.0 / 10.3 A
 Start Winding Resistance: 11.00 Ω at 25°C
 Run Winding Resistance: 7.10 Ω at 25°C
 Phase : 1 ph

External Characteristics

Internal Diameter (mm)
 Suction Connector 6.5
 Discharge Connector 4.9
 Process Connector 6.5
 Material Copper

Electrical Components

Component Type
 Starting Device: PTC 14Ω
 Motor Protection: T0683/xx

Circuit Diagram for Mod.90 Terminal Board

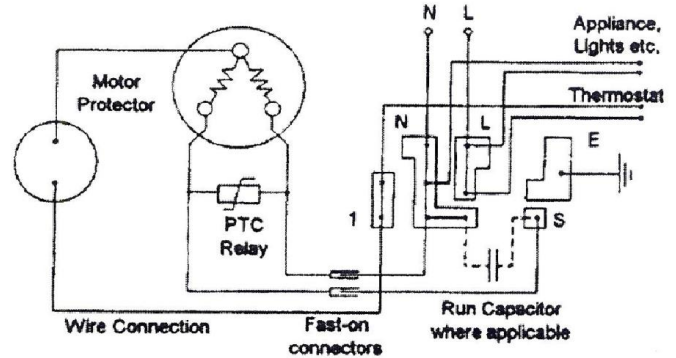

Circuit Diagram for U.H. Terminal Board

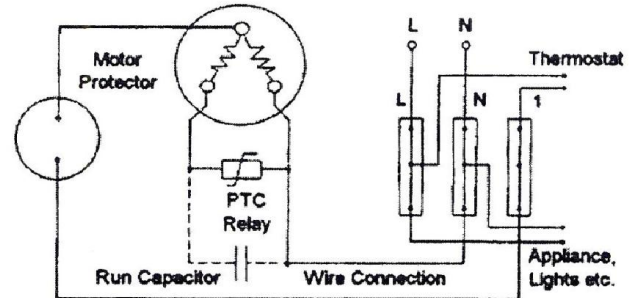

Recommended Transport Positions when fitted into appliances

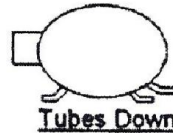
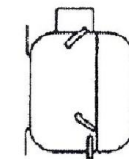
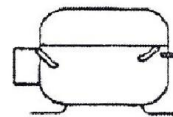

MCMC compressors reserves the right to change the data without prior notice

10th of Ramadan City - (Cairo) Egypt
 Industrial Zone A-2
 P.o Box : 1001 (10th of Ramadan)
 Tel. : 0554 - 413322 (10 lines)
 Fax. : 0554 - 413161 - 413029
 Web site : http://www.zmcegypt.com

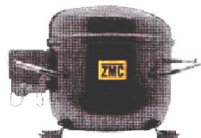

العاشر من رمضان
 المنطقة الصناعية أ - ٢
 ص.ب : ١٠٠١ العاشر من رمضان
 تليفون : ٤١٣٣٢٢ - ٠٥٥٤ (١٠ خطوط)
 فاكس : ٤١٣١٦١ - ٤١٣٠٢٩ (٠٥٥٤)

PERFORMANCE CURVE DATA : 50Hz

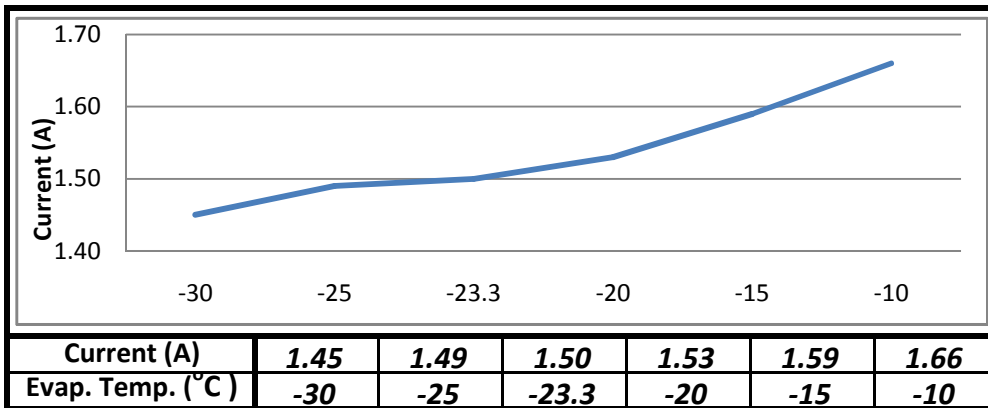
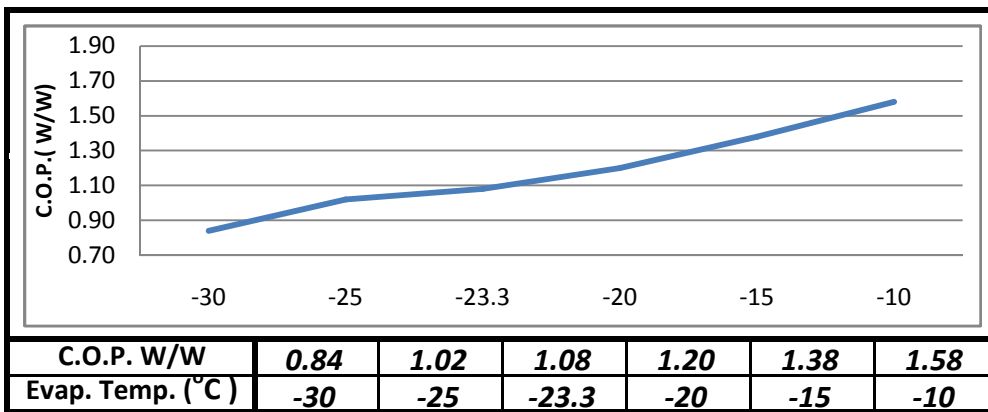
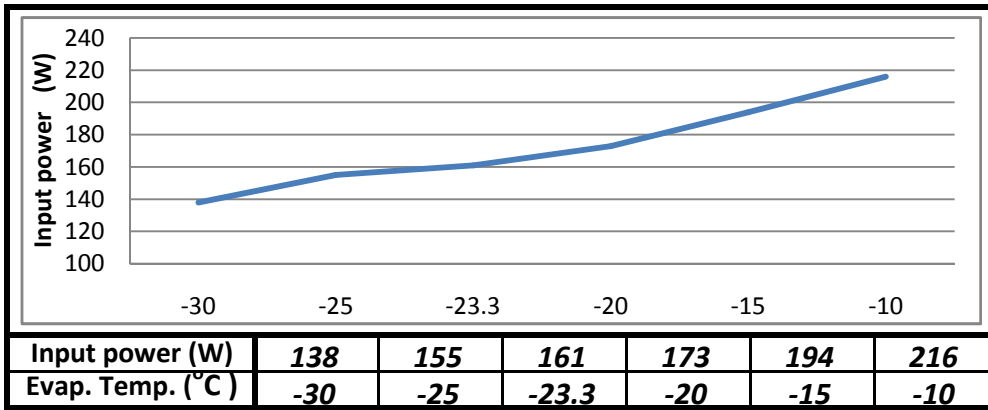
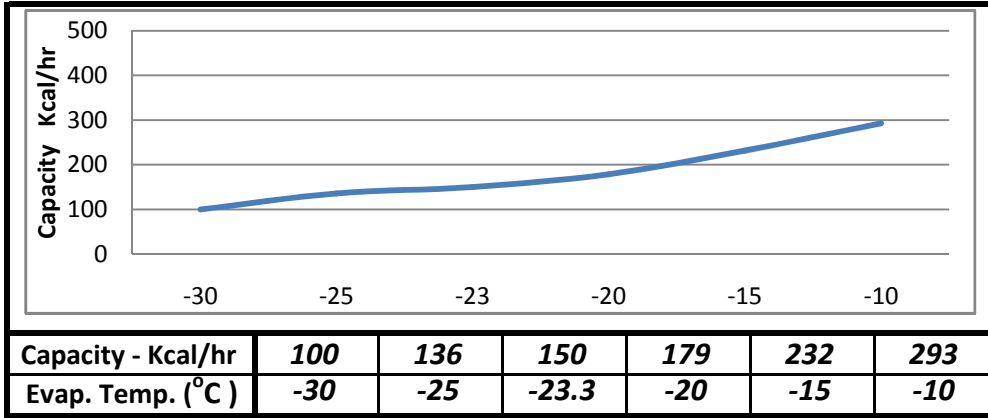

Test Condition: Ashrae, Static, Return Gas 32°C Subcooling OK, Evaporating: 23.3°C, Condensing: 55°C , Ambient: 32°C

10th of Ramadan City - (Cairo) Egypt
 Industrial Zone A-2
 P.o Box : 1001 (10th of Ramadan)
 Tel. : 0554 - 413322 (10 lines)
 Fax. : 0554 - 413161 - 413029
 Web site : <http://www.zmcegypt.com>



العاشر من رمضان
 المنطقة الصناعية أ - ٢
 ص.ب : ١٠٠١ العاشر من رمضان
 تليفون : ٤١٣٣٢٢ - ٠٥٥٤ (١٠ خطوط)
 فاكس : ٤١٣١٦١ - ٤١٣٠٢٩ (٠٥٥٤)

PERFORMANCE CURVE DATA : 60Hz

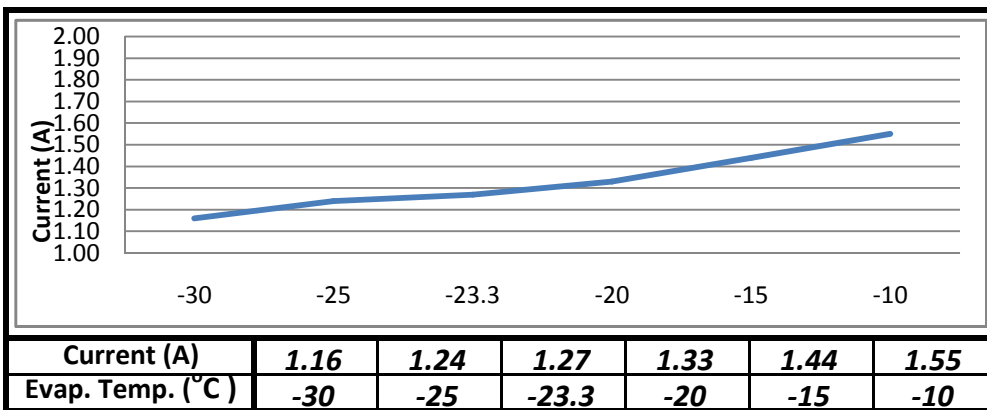
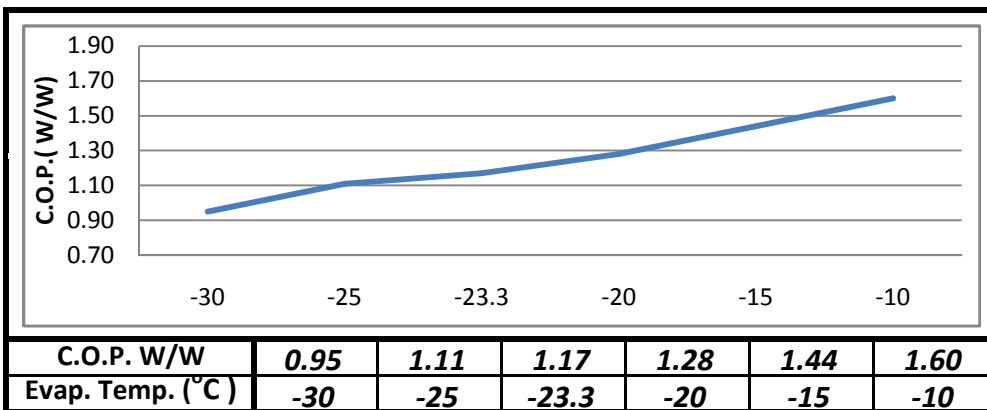
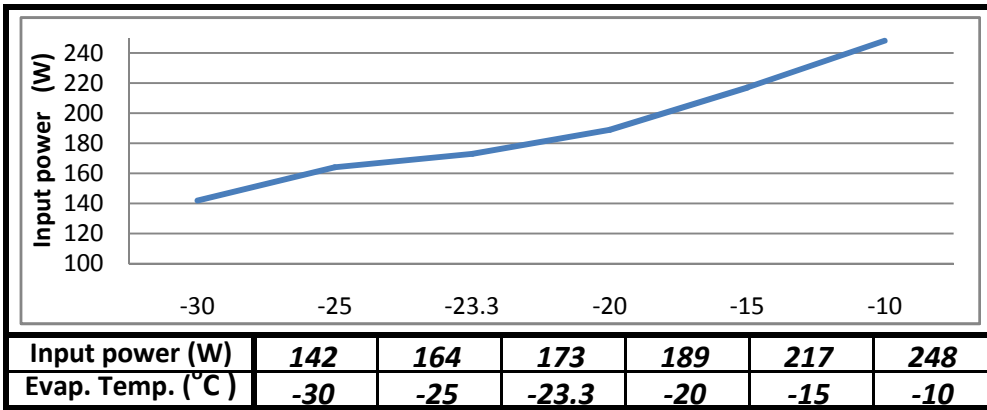
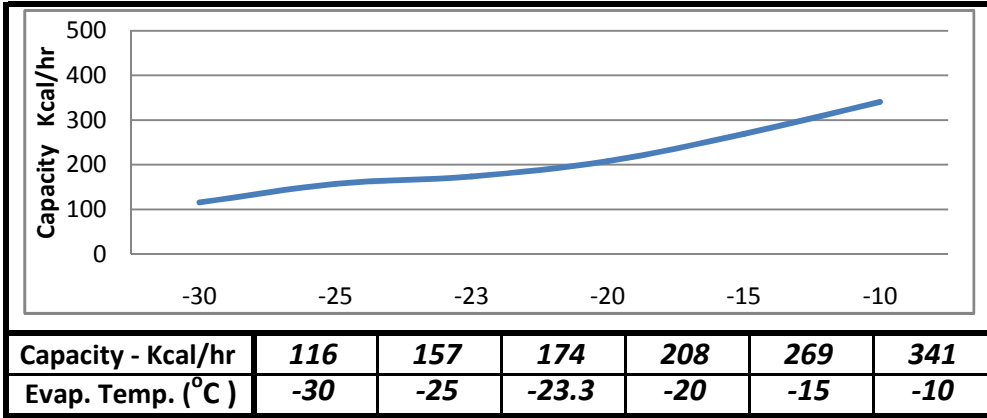

Test Condition: Ashrae, Static, Return Gas 32°C Subcooling OK, Evaporating: 23.3°C, Condensing: 55°C , Ambient: 32°C

10th of Ramadan City - (Cairo) Egypt
 Industrial Zone A-2
 P.o Box : 1001 (10th of Ramadan)
 Tel. : 0554 - 413322 (10 lines)
 Fax. : 0554 - 413161 - 413029
 Web site : <http://www.zmcegypt.com>

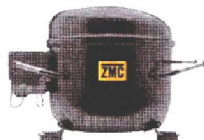

العاشر من رمضان
 المنطقة الصناعية أ - ٢
 ص.ب : ١٠٠١ العاشر من رمضان
 تليفون : ٤١٣٣٢٢ - ٠٥٥٤ (١٠ خطوط)
 فاكس : ٤١٣١٦١ - ٤١٣٠٢٩ (٠٥٥٤)

GM, GN and GL models		HL and HP models	
Standard dimensions for mounting hole centres: 170x70 mm			
<i>Special feet</i>			
Models	Distance between holes	Holes diameter	
GM/GN/HL/HP/GP	165 x 101.6	4 x 19	
	170 x 70	6 x 165	
Tube internal diameter "GM", "GN", "GL", "HL"		"HP" and "GP"	
Material	Suction	Service	Discharge
Copper steel / copper	6.1	6.1	4.9
Copper	6.1	6.1	5.1
Copper	6.5	6.5	4.9
Copper	8.1	8.1	6.5

Mounting accessories

Standard	Standard

10th of Ramadan City - (Cairo) Egypt
 Industrial Zone A-2
 P.o Box : 1001 (10th of Ramadan)
 Tel. : 0554 - 413322 (10 lines)
 Fax. : 0554 - 413161 - 413029
 Web site : <http://www.zmcegypt.com>

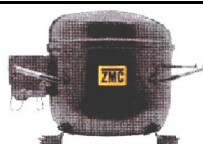

العاشر من رمضان
 المنطقة الصناعية أ - ٢
 ص.ب : ١٠٠١ العاشر من رمضان
 تليفون : ٤١٣٣٢٢ - ٠٥٥٤ (١٠ خطوط)
 فاكس : ٤١٣١٦١ - ٤١٣٠٢٩ (٠٥٥٤)

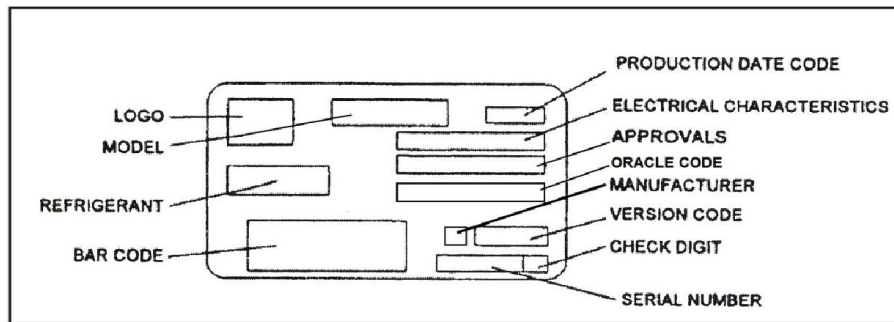
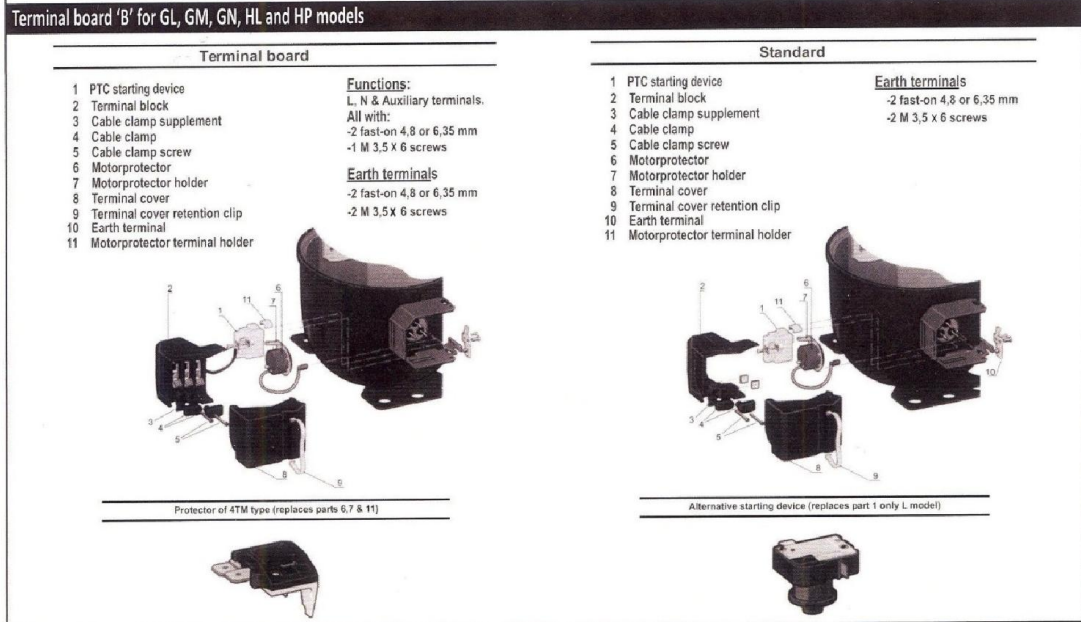
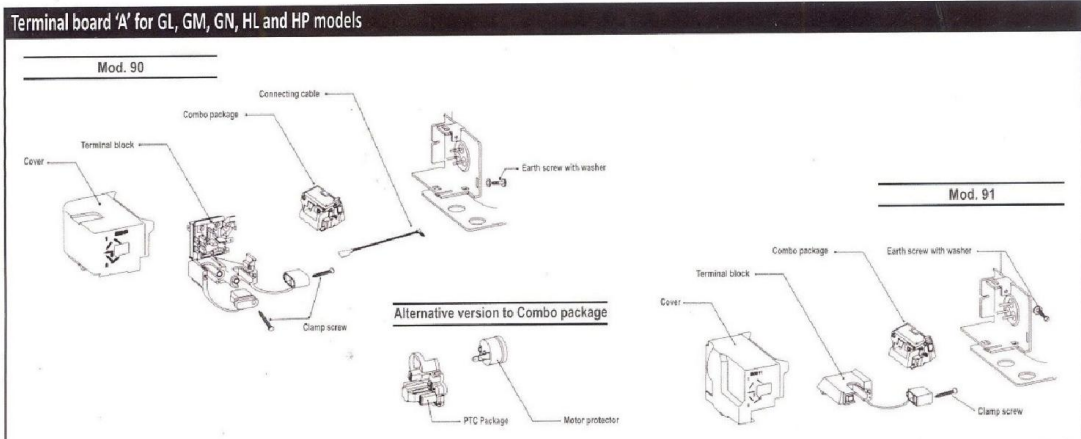

10th of Ramadan City - (Cairo) Egypt
 Industrial Zone A-2
 P.o Box : 1001 (10th of Ramadan)
 Tel. : 0554 - 413322 (10 lines)
 Fax. : 0554 - 413161 - 413029
 Web site : <http://www.zmcegypt.com>



العاشر من رمضان
 المنطقة الصناعية أ - ٢
 ص.ب : ١٠٠١ العاشر من رمضان
 تليفون : ٠٥٥٤ - ٤١٣٣٢٢ (١٠ خطوط)
 فاكس : ٠٥٥٤ - ٤١٣١٦١ - ٤١٣٠٢٩