

Compressor Technical Data

Model **GP14TB** Code **356500106816**

HMBP

General Data

Refrigerant:	R134a
Application:	HMBP
Evaporating Temperature Range:	-25°C to +10°C
Voltage/Frequency:	220-240V 50Hz 1~
Compressor Cooling:	Fan Cooling
Expansion Device:	Capillary / Valve
Packaging Quantity:	Multi - 96:120 pcs
Approvals:	CE-GOST



Mechanical Data

Oil Charge:	450 cm ³
Oil Type Configuration:	ester
Oil Type Viscosity:	19 cSt
Weight:	12 kg

Electrical Data

Motor Type:	CSIR
Voltage working range at 50 Hz:	187-264V
Maximum Motor Temperature:	130°C
Locked Rotor Current:	17.8 A
Start Winding Resistance:	22 Ω at 25°C
Run Winding Resistance:	4.15 Ω at 25°C
Phase :	1 ph

External Characteristics

Internal Diameter	(mm)
Suction Connector	8.1
Discharge Connector	6.5
Process Connector	8.1
Material	Copper

Electrical Components

Component Type	
Starting Device:	RELAY MTRP48
Motor Protection:	T0425/xx
Start Capacitor	47-56μf

MCMC compressors reserves the right to change the data without prior notice

10th of Ramadan City - (Cairo) Egypt
Industrial Zone A-2
P.o Box : 1001 (10th of Ramadan)
Tel. : 0554 - 413322 (10 lines)
Fax. : 0554 - 413161 - 413029
Web site : <http://www.zmcegypt.com>

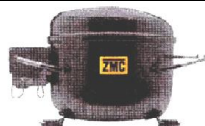

CSIR

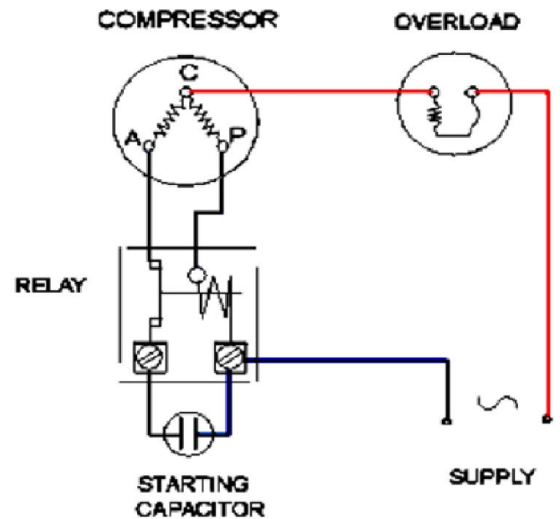

Recommended Transport Positions when fitted into appliances

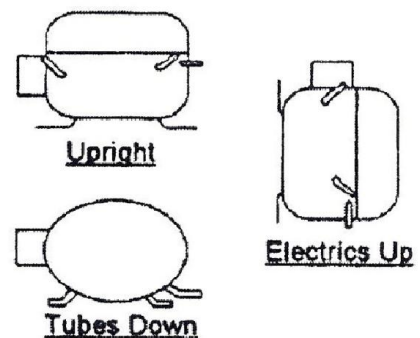

العاشر من رمضان
المنطقة الصناعية أ - ٢
ص.ب: ١٠٠١ العاشر من رمضان
تليفون: ٤١٣٣٢٢ - ٠٥٥٤ (١٠ خطوط)
فاكس: ٤١٣١٦١ - ٤١٣٠٢٩ (٠٥٥٤)

PERFORMANCE CURVE DATA :

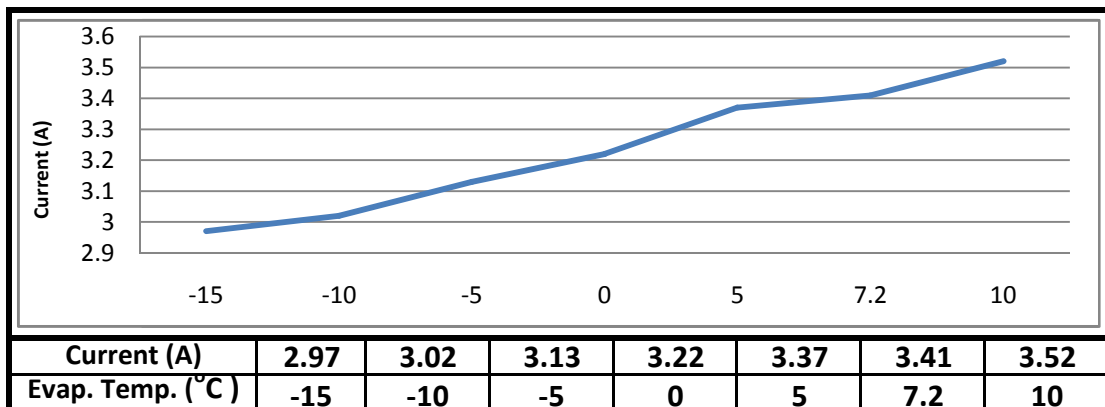
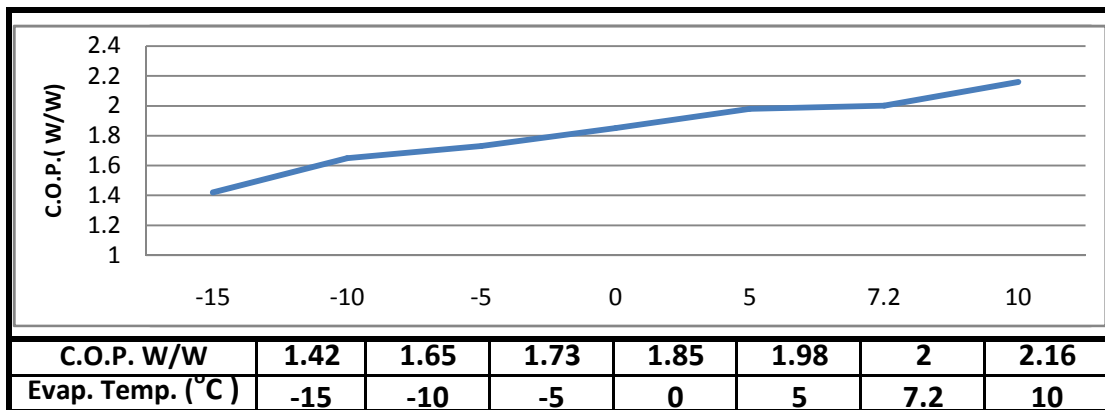
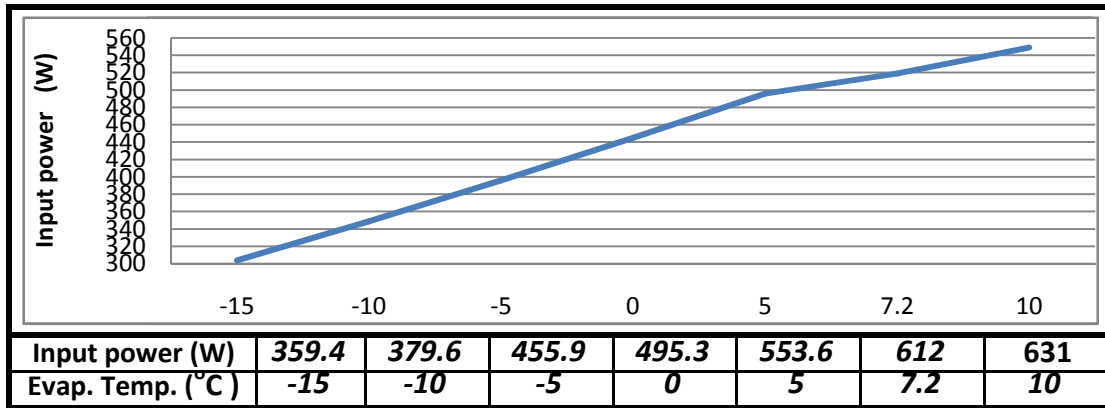
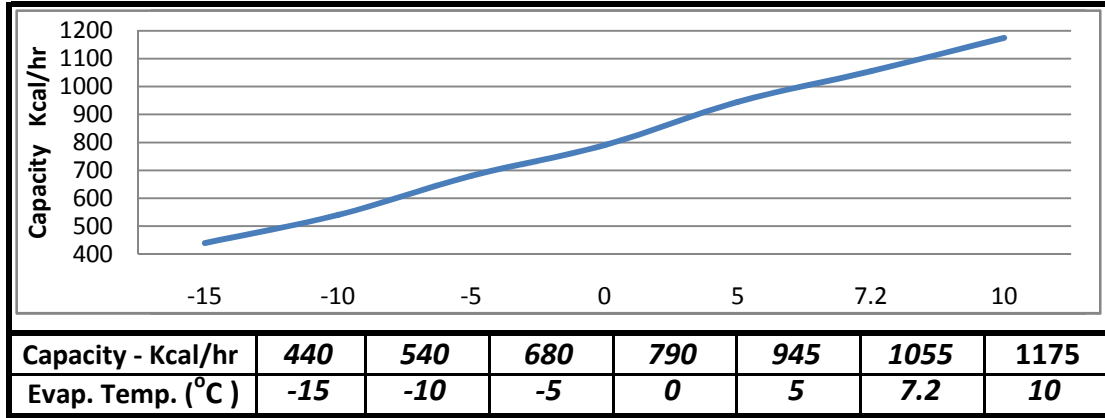

Test Condition: Ashrae, Fan Cooling, Return Gas:35 °C , Ambient: 35°C Subcooling 46 °C, Evaporating: 7.2 oC, Condensing: 55°C

10th of Ramadan City - (Cairo) Egypt
 Industrial Zone A-2
 P.o Box : 1001 (10th of Ramadan)
 Tel. : 0554 - 413322 (10 lines)
 Fax. : 0554 - 413161 - 413029
 Web site : <http://www.zmcegypt.com>

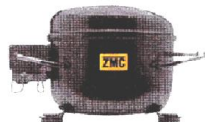

العاشر من رمضان
 المنطقة الصناعية أ - ٢
 ص.ب : ١٠٠١ العاشر من رمضان
 تليفون : ٤١٣٣٢٢ - ٠٥٥٤ (١٠ خطوط)
 فاكس : ٤١٣١٦١ - ٤١٣٠٢٩ (٠٥٥٤)

GM, GN and GL models

HL and HP models

Standard dimensions for mounting hole centres: 170x70 mm

Special feet

Models	Distance between holes	Holes diameter
GM/GN/HL/HP/GP	165 x 101.6	4 x 19
	170 x 70	6 x 165

Material	Tube internal diameter "GM", "GN", "GL", "HL"			"HP" and "GP"		
	Suction	Service	Discharge	Suction	Service	Discharge
Copper steel / copper	6.1	6.1	4.9			
Copper	6.1	6.1	5.1			
Copper	6.5	6.5	4.9			
Copper	8.1	8.1	6.5			

Mounting accessories

Standard

Standard



Terminal board 'A' for GL, GM, GN, HL and HP models

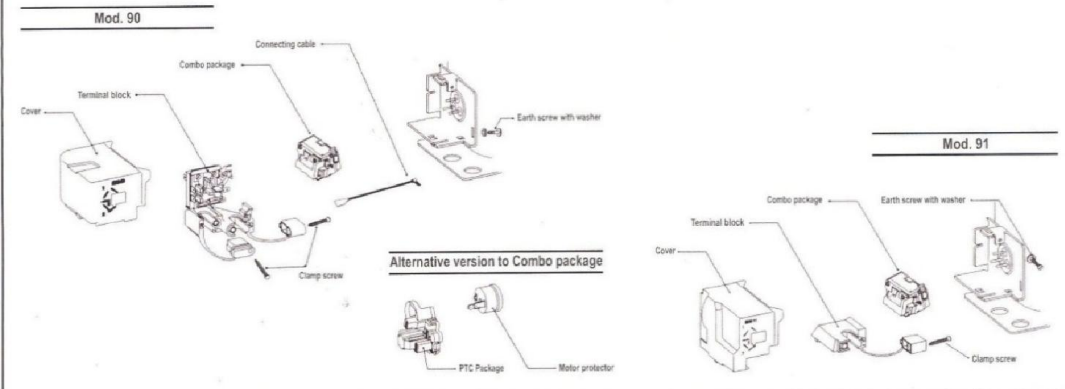

Terminal board 'B' for GL, GM, GN, HL and HP models

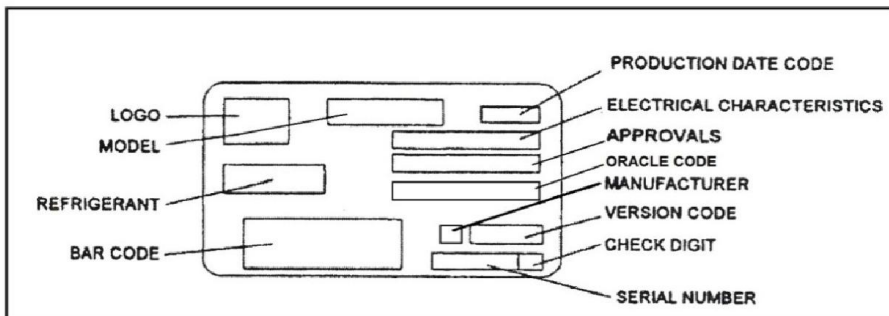
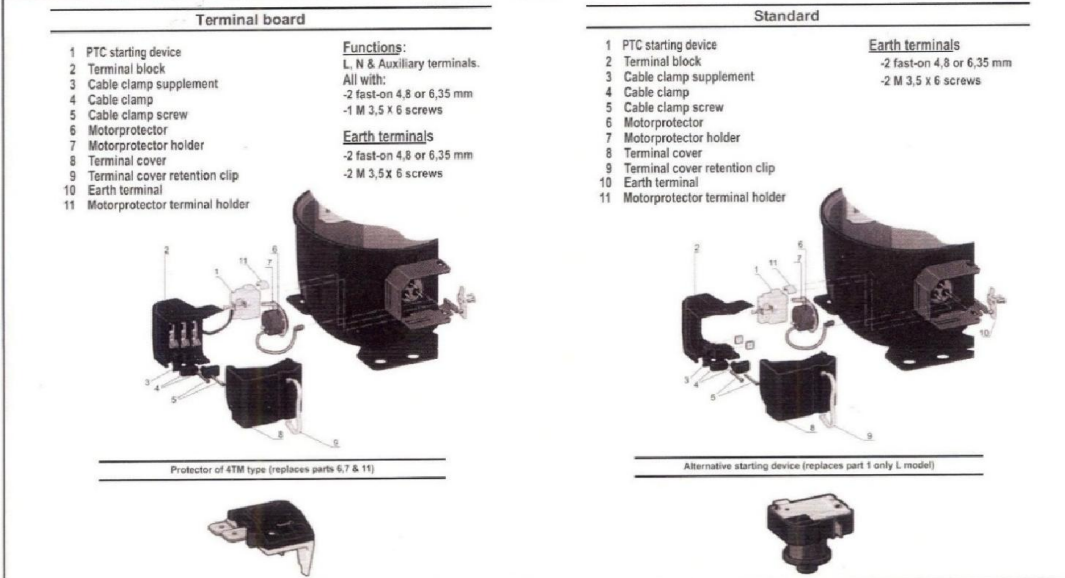

10th of Ramadan City - (Cairo) Egypt
 Industrial Zone A-2
 P.o Box : 1001 (10th of Ramadan)
 Tel. : 0554 - 413322 (10 lines)
 Fax. : 0554 - 413161 - 413029
 Web site : <http://www.zmcegypt.com>



العاشر من رمضان
 المنطقة الصناعية أ - ٢
 ص.ب : ١٠٠١ العاشر من رمضان
 تليفون : ٠٥٥٤ - ٤١٣٣٢٢ (١٠ خطوط)
 فاكس : ٤١٣١٦١ - ٤١٣٠٢٩ (٠٥٥٤)